

Ронда КР-140

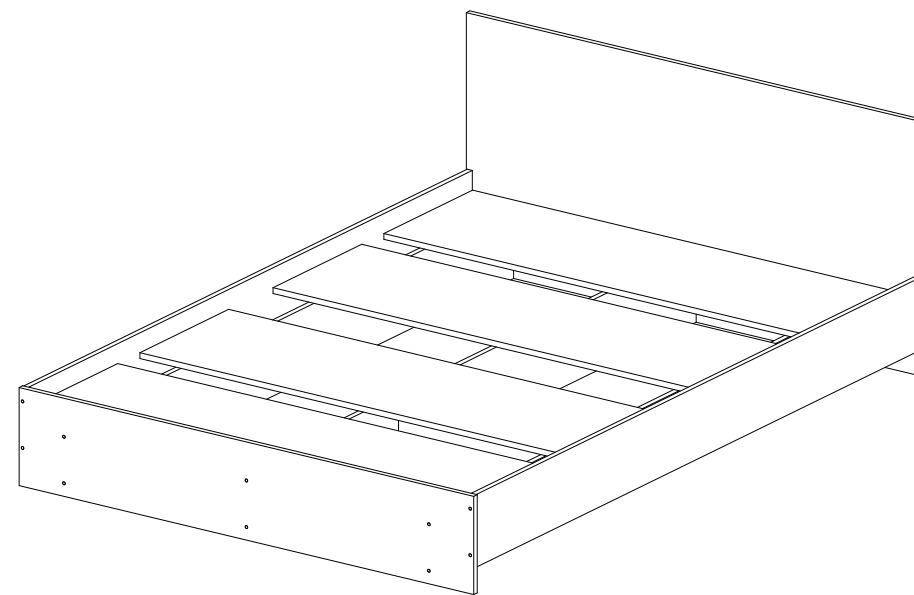

1435	700	2032

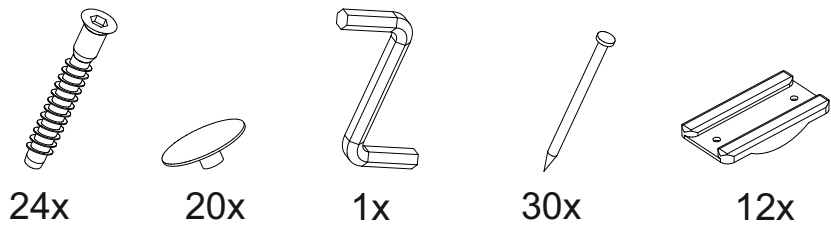
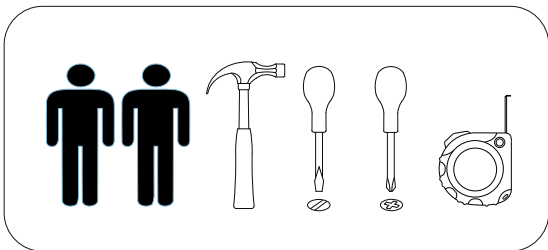

№ дет.	Деталь/Detail	Размер/Size	Кол-во/ Quantity	№ упак./ № pack
1-2	Царга/Side panel	2000x200	2	1/4
3-4	Усиление/Plank	2000x200	2	1/4
5	Усиление/Plank	2000x200	1	1/4
6	Щиток головной/Panel	700x1435	1	2/4
7	Щиток ножной/Panel	270x1435	1	2/4
8-9	Усиление/Plank	560x100	2	2/4
10-13	Основание ДСП/Footing	1395x400	4	3/4

1

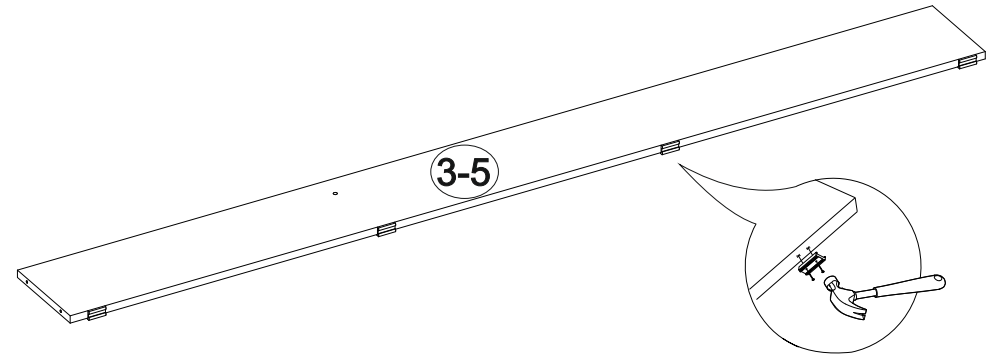

2

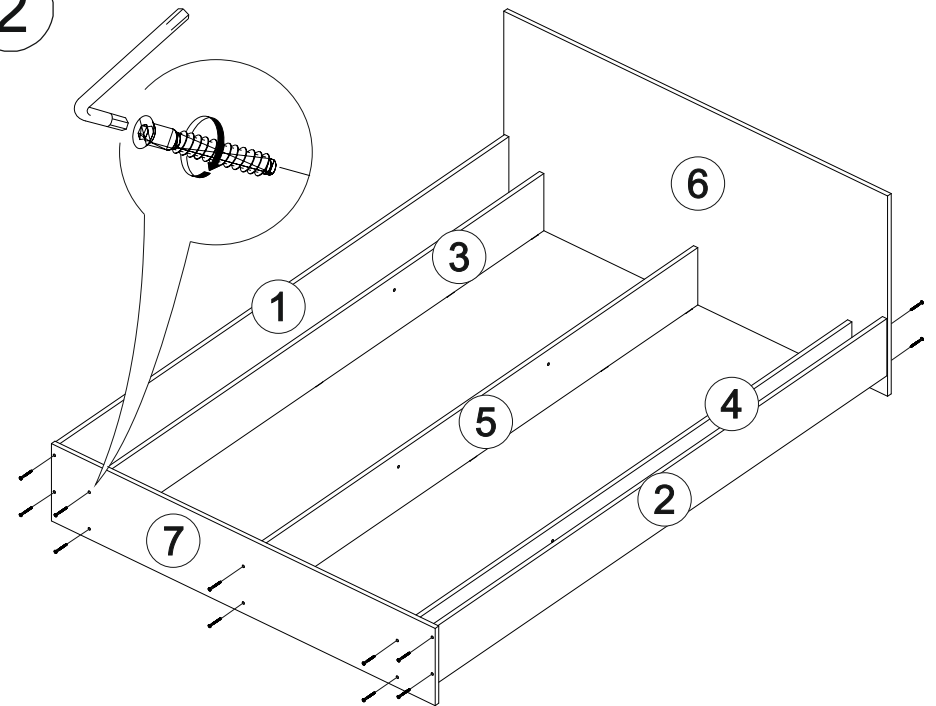

3

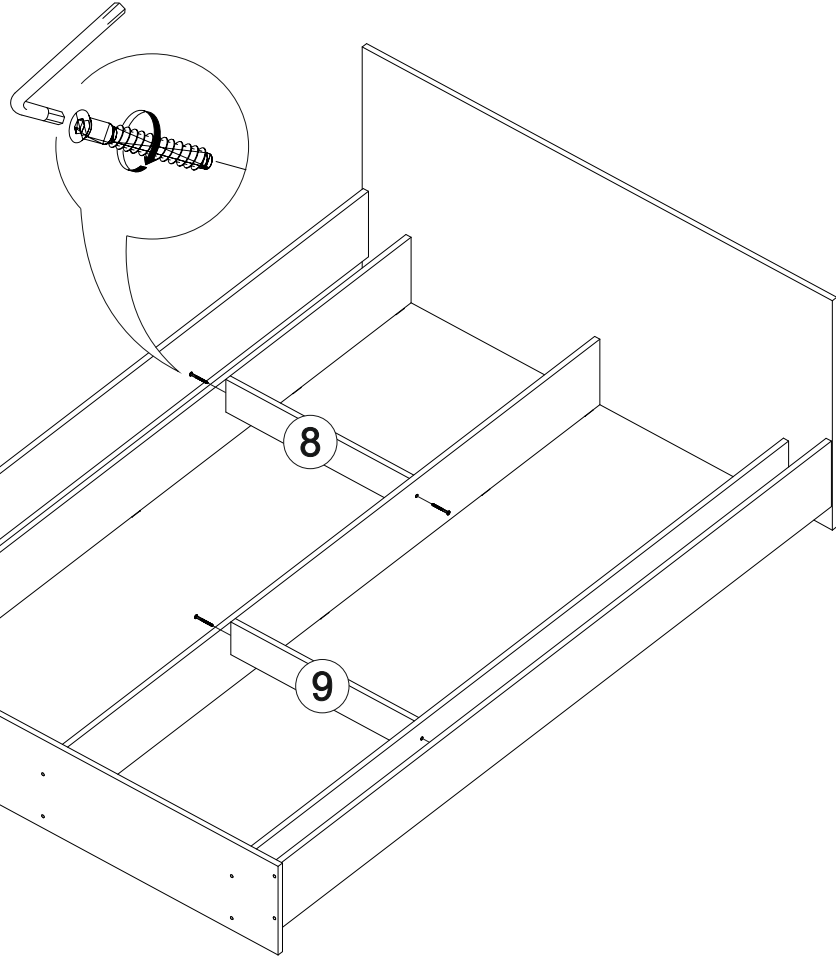

4

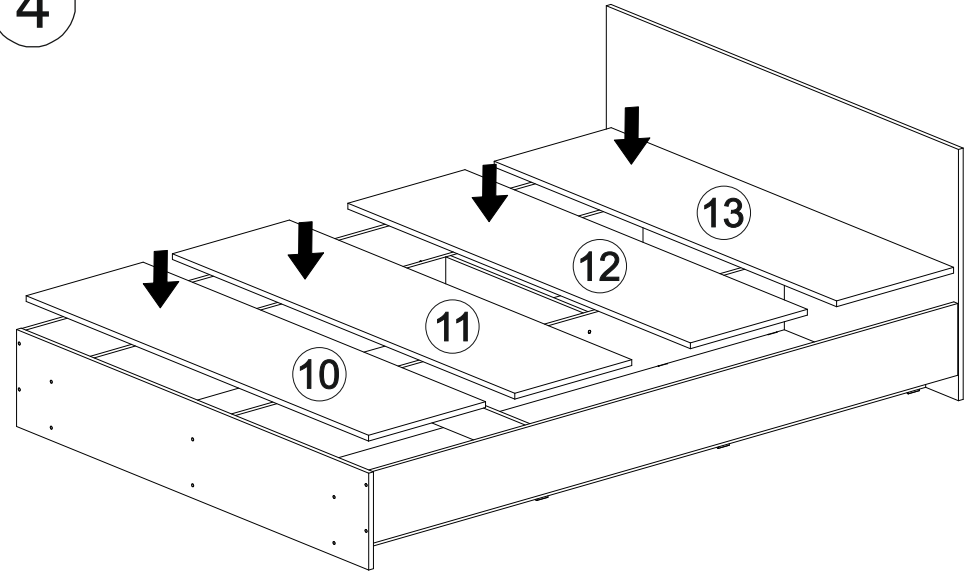

5

